

CRUCES CARDAN (Fijación interior)

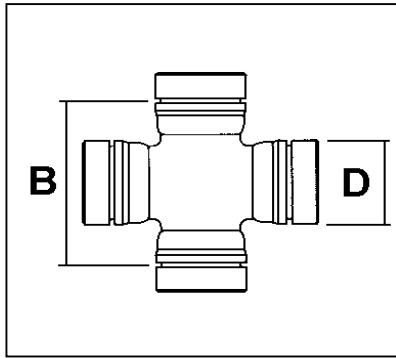

ESTÁNDAR

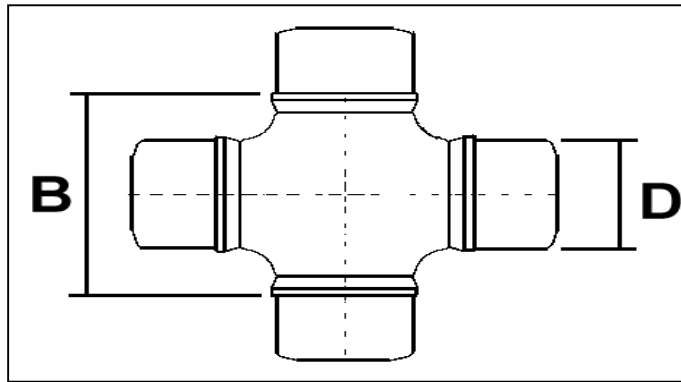

INDUSTRIAL

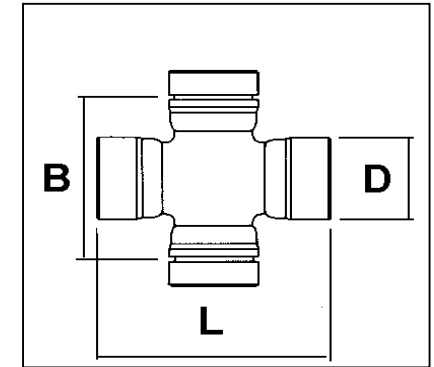

MIXTA

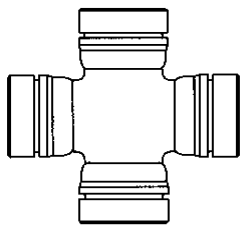

FIG. 1

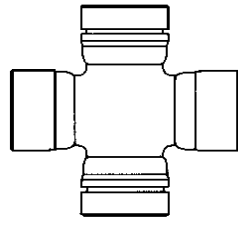

FIG. 2

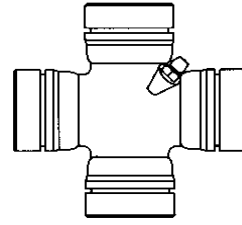

FIG. 3

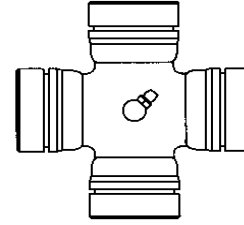

FIG. 4

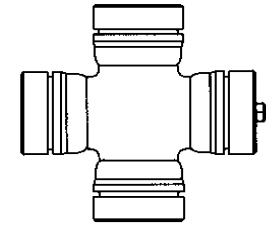

FIG. 5

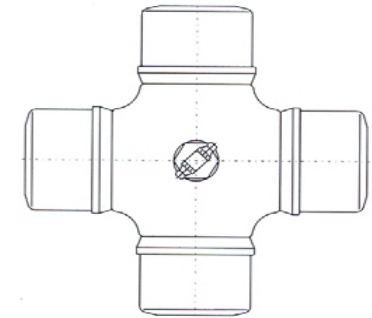

FIG. 6

CRUCES CARDAN (Fijación interior)



REF. Cardyfren	FIG.	SERIE	Ø D	B	OBSERVACIONES	EQUIV.	REF. ANTIGUA
40 21601	1		16,00	24,50 / 27,00	KAWASAKI / Engrase a vida		
40 22001	5		20,01	35,17 / 39,17	NISSAN / Engrasador en un dado		40 200 0347 04A
40 22205	5		22,00	36,10 / 40,40	FORK LIFT / Engrasador en un dado		
40 22201	4		22,00	37,50 / 40,00	TCM / Engrase central		
40 22204	1		22,00	37,60 / 39,60	MITSUBISHI / Engrase a vida		
40 22202	5		22,50	34,80 / 39,24	MAZDA / Engrasador en un dado	385	40 225 0346 04A

CRUCES CARDAN (Fijación interior)



40 22203	5		22,57	34,94 / 38,50	DAIHATSU/ Engrasador en un dado			40 225 0347 04A
40 22301	4		23,82	34,98 / 38,98	Engrasador central	338		40 238 0346 01A
40 22401	5		24,00	40,00 / 45,17	Engrasador en un dado		SF5-271X	40 240 0400 04A
40 22402	4		24,60	33,70 / 36,70	Engrasador central			
40 22501	5		25,00	40,00 / 45,30	NISSAN/ SUBARU / Engrasador en un dado			40 250 0400 04A
40 22502	5		25,00	40,00 / 44,71	MAZDA / Engrasador en un dado			40 250 0412 04A
40 22503	5		25,40	39,63 / 45,09	Engrasador en un dado			40 254 0394 04A
40 22504	1		25,40	55,98 / 61,11	Engrasada a vida			40 254 0559 03A
40 22601	5		26,00	42,00 / 47,67	TOYOTA / Engrasador en un dado			40 260 0420 04A
40 22602	1		26,00	53,74 / 57,69	TOYOTA / Engrasada a vida			40 260 0534 03A
40 22603	5		26,50	48,00 / 52,00	MAZDA / Engrasador en un dado			40 265 0480 04A
40 22604	4		26,97	44,50 / 46,10	Engrasador central			
40 22701	1		27,00	46,10 / 49,10	NISSAN / Engrasada a vida			40 270 0460 03A
40 22705	1		27,00	49,10	NISSAN / Engrasada a vida			
40 22702	1		27,00	52,67 / 56,81	O.E. JEEP CHEROKEE / Engrasada a vida (DANA)		5-260XE	40 270 0526 03A
40 22703	3		27,00	68,04 / 72,04	Engrasador lateral	433	5-1203X	40 270 0676 00A
40 22704	3		27,40	50,88 / 55,20	DODGE / Engrasador lateral	315G	5-1306X	40 274 0510 00A
40 22806	3		28,00	49,00 / 53,65	Engrasador lateral			
40 22801	3		28,00	49,00 / 53,65	MERCEDES 406 / Engrasador lateral			40 280 0490 03A
40 22802	3		28,00	53,10 / 59,79	NISSAN / Engrasador lateral			40 280 0530 00A
40 22807	5		28,00	53,20 / 59,50	MAZDA / Engrasador en 1 dado.			
40 22804	3		28,00	52,60 / 55,60	SUBARU, TOYOTA RANGER /Engrasador lateral			
40 22803	5		28,57	51,04 / 55,30	TOYOTA HI-LUX / Engrasador a 1 dado			
40 22803-1	5		28,58	49,00 / 53,80	TOYOTA / Engrasador a 1 dado			
40 22805	3		28,60	60,20 / 64,90	CHEVROLET, GM / Engrasador lateral			
40 22905	4		29,00	49,16 / 53,57	TOYOTA HI-LUX / Engrasador central			
40 22901	5		29,00	49,16 / 53,57	TOYOTA LAND CRUISER / Engrasador en 1 dado			40 290 0490 03A
40 22906	5		29,00	49,16 / 53,57	TOYOTA LAND CRUISER / Engrasador en 1 dado			
40 22902	3		29,00	50,11 / 54,20	ISUZU / Engrasador lateral			40 290 0500 00A
40 22903	1		29,00	51,90 / 56,20	OPEL / Engrasada a vida			40 290 0520 01A
40 23001	4		30,00	55,10 / 58,10	MITSUBISHI / Engrasador central			40 300 0550 01A
40 23006	3		30,00	57,00 / 60,88	Engrasador lateral			
40 23002	4		30,00	57,00 / 60,00	ARO / Engrasador central			
40 23008	4		30,00	58,10	MITSUBISHI / Engrasador central			
40 23003	4		30,00	71,20 / 74,20	MITSUBISHI / Engrasador central			
40 23007	1		30,11	52,58 / 56,68	Engrasada a vida (DANA)		5-297XE	40 301 0556 03A
40 23004	1		30,11	52,58 / 56,68	Engrasada a vida			
40 23005	1		30,20	52,40 / 55,50	CHRYSLER / Engrasada a vida			40 302 0528 03A
40 23102	1		31,02	45,10 / 48,10	FORD / Engrasada a vida			40 312 0441 03A

CRUCES CARDAN (Fijación interior)



40 23103	4		31,25	46,00 / 51,50	Engrasador central			
40 23101	4		31,25	51,00 / 55,00	DKW / Engrasador central			
40 23201	3		32,00	61,16 / 66,09	TOYOTA / Engrasador lateral			40 320 0610 00A
40 23202	4		32,00	64,00 / 68,00	NISSAN / Engrasador central			
40 23301	4		33,40	66,10 / 70,90	Engrasador central			
40 23402	4		34,00	51,30 / 56,30	Engrasador central			
40 23401	3		34,90	72,20 / 76,10	DODGE / Engrasador lateral			
40 23701-3	4		37,00	67,00 / 72,01	MAZDA / Engrasador central			
40 23701-2	4		37,00	67,00 / 72,01	MAZDA / Engrasador central			
40 23701	4		37,00	67,00 / 72,00	MAZDA / Engrasador central			
40 23801	4		38,00	57,20 / 62,00	MERCEDES / Engrasador central			40 380 0560 01A
40 24201	4		42,00	66,40 / 72,00	MERCEDES / Engrasador central			40 420 0664 01A
40 26501	6	0080	65,00	144,00	Engrasador central / Fijacion con medias lunas	190.50	2110-80-05/04	
40 26502	6	1955	65,00	144,00	Engrasador lateral / Fijacion con medias lunas	190.50		
3860 4001 A	4	3860	68,00	89,00 / 96,00	MERCEDES / Engrasador central	385.60		3860 4001 A
40 26801	1	3860	68,00	89,00 / 96,00	MERCEDES / Engrasada a vida	385.60		
0079 4003 A	1	0079	68,00	117,00 / 123,00	O.E. MERCEDES / Engrasada a vida (GEWES)	79	2110-79-31/03	0079 4003 A
40 27402	6		74,00	129,00	Engr. lateral / Fijación con medias lunas (GWB)	392.50		
40 27401	6	0082	74,00	154,00	Engr. central / Fijación medias lunas (GEWES)	82 / 190.55	2110-82-05/13	40 740 1540 00U
40 28303	6		83,00	129,00	Engr. lateral / Fijación con medias lunas (GWB)	390.60		
40 28301	6	0085	83,00	139,00	Engr. central / Fijación medias lunas (GEWES)	85 / 392.55	2112-85-10/02	40 830 1390 00U
40 28302	6	0086	83,00	175,00	Engr. central / Fijación medias lunas (GEWES)	86 / 190.60	2110-85-05/02	40 830 1750 00U
40 29502	6	0090	95,00	139,00	Engr. central / Fijación medias lunas (GEWES)	390.65	2112-90-02/13	
40 29503	6	0090	95,00	160,00	Engr. central / Fijación medias lunas (GEWES)	392.60	2112-90-01/13	
40 29501	6	0090	95,00	190,00	Engr. central / Fijación medias lunas (GEWES)	190,65	2110-90-01/13	
40 211001	6	0095	110,00	160,00	Engr. central / Fijacion con medias lunas (GEWES)	390.70	2112-95-02/13	40 110 1600 01U
40 211004	6		110,00	160,00	Engr. central / Fijacion con medias lunas (GWB)	390.70		7.390.70.0600000
40 211003	6		110,00	176,00	Engr. lateral / Fijación con medias lunas (GWB)	392.65		
40 211002	6		110,00	210,00	Engr. lateral / Fijación con medias lunas (GWB)	190.70		
40 211002	6		110,00	210-350	Engr. lateral / Fijación con medias lunas (GWB)	190.70		
40 212001	6		120,00	176,00	Engr. lateral / Fijación con medias lunas (GWB)	390.75		
40 212002	6		120,00	196,00	Engr. lateral / Fijación con medias lunas (GWB)	392.70		
40 212003	6		120,00	235,00	Engr. lateral / Fijación con medias lunas (GWB)	190.75		
40 213003	6		130,00	196,00	Engr. lateral / Fijación con medias lunas (GWB)	390.80		
40 213001	6		130,00	216,00	Engr. lateral / Fijación con medias lunas (GWB)	292.75 / 392.75		
40 213002	6		130,00	262,00	Engr. lateral / Fijación con medias lunas (GWB)	190.80		